

# Bảng thông số sản phẩm

Thông số kỹ thuật



variable speed drive, Altivar 12,  
1.5kW, 2hp, 200 to 240V, 1 phase,  
with heat sink

ATV12HU15M2

## Main

Range of product	Altivar 12
product or component type	Variable speed drive
Product specific application	Simple machine
mounting mode	Cabinet mount
Communication port protocol	Modbus
Supply frequency	50/60 Hz +/- 5 %
[Us] rated supply voltage	200...240 V - 15...10 %
Nominal output current	7.5 A
Motor power hp	2 hp
Motor power kW	1.5 kW
Motor power hp	2 hp
EMC filter	Integrated
IP degree of protection	IP20

## Complementary

Discrete input number	4
Discrete output number	2
Analogue input number	1
Analogue output number	1
Relay output number	1
Physical interface	2-wire RS 485
Connector type	1 RJ45
Continuous output current	7.5 A at 4 kHz
Method of access	Server Modbus serial
Speed drive output frequency	0.5...400 Hz
Speed range	1...20
Sampling duration	20 ms, tolerance +/- 1 ms for logic input 10 ms for analogue input
Linearity error	+/- 0.3 % of maximum value for analogue input
Frequency resolution	Analog input: converter A/D, 10 bits Display unit: 0.1 Hz
Time constant	20 ms +/- 1 ms for reference change

<b>Transmission rate</b>	9.6 kbit/s 19.2 kbit/s 38.4 kbit/s
<b>Transmission frame</b>	RTU
<b>Number of addresses</b>	1...247
<b>Data format</b>	8 bits, configurable odd, even or no parity
<b>Communication service</b>	Read holding registers (03) 29 words Write single register (06) 29 words Write multiple registers (16) 27 words Read/write multiple registers (23) 4/4 words Read device identification (43)
<b>Type of polarization</b>	No impedance
<b>4 quadrant operation possible</b>	False
<b>Asynchronous motor control profile</b>	Sensorless flux vector control Quadratic voltage/frequency ratio Voltage/frequency ratio (V/f)
<b>Maximum output frequency</b>	4 kHz
<b>Transient overtorque</b>	150...170 % of nominal motor torque depending on drive rating and type of motor
<b>Acceleration and deceleration ramps</b>	U S Linear from 0 to 999.9 s
<b>Motor slip compensation</b>	Adjustable Preset in factory
<b>Switching frequency</b>	2...16 kHz adjustable 4...16 kHz with derating factor
<b>Nominal switching frequency</b>	4 kHz
<b>Braking to standstill</b>	By DC injection
<b>Brake chopper integrated</b>	False
<b>Line current</b>	17.8 A at 100 V (heavy duty) 14.9 A at 120 V (heavy duty)
<b>Maximum input current</b>	14.9 A
<b>Maximum output voltage</b>	240 V
<b>Apparent power</b>	3.6 kVA at 240 V (heavy duty)
<b>Maximum transient current</b>	11.2 A during 60 s (heavy duty) 12.4 A during 2 s (heavy duty)
<b>Network frequency</b>	50...60 Hz
<b>Relative symmetric network frequency tolerance</b>	5 %
<b>Prospective line I<sub>sc</sub></b>	1 kA
<b>Base load current at high overload</b>	7.5 A
<b>Power dissipation in W</b>	Forced cooling: 72.0 W
<b>With safety function Safely Limited Speed (SLS)</b>	False
<b>With safety function Safe brake management (SBC/SBT)</b>	False
<b>With safety function Safe Operating Stop (SOS)</b>	False
<b>With safety function Safe Position (SP)</b>	False
<b>With safety function Safe programmable logic</b>	False
<b>With safety function Safe Speed Monitor (SSM)</b>	False

With safety function Safe Stop 1 (SS1)	False
With sft fct Safe Stop 2 (SS2)	False
With safety function Safe torque off (STO)	False
With safety function Safely Limited Position (SLP)	False
With safety function Safe Direction (SDI)	False
Protection type	Line supply overvoltage Line supply undervoltage Overcurrent between output phases and earth Overheating protection Short-circuit between motor phases Against input phase loss in three-phase Thermal motor protection via the drive by continuous calculation of I <sup>2</sup> t
Tightening torque	1.2 N.m
Insulation	Electrical between power and control
Quantity per set	Set of 1
Width	105 mm
Height	142 mm
Depth	156.2 mm
net weight	1.4 kg

## Environment

Operating altitude	> 1000...2000 m with current derating 1 % per 100 m <= 1000 m without derating
Operating position	Vertical +/- 10 degree
Product certifications	NOM CSA C-Tick UL GOST RCM KC
marking	CE
Standards	UL 508C UL 618000-5-1 EN/IEC 61800-5-1 EN/IEC 61800-3
Assembly style	With heat sink
Electromagnetic compatibility	Electrical fast transient/burst immunity test level 4 conforming to EN/IEC 61000-4-4 Electrostatic discharge immunity test level 3 conforming to EN/IEC 61000-4-2 Immunity to conducted disturbances level 3 conforming to EN/IEC 61000-4-6 Radiated radio-frequency electromagnetic field immunity test level 3 conforming to EN/IEC 61000-4-3 Surge immunity test level 3 conforming to EN/IEC 61000-4-5 Voltage dips and interruptions immunity test conforming to EN/IEC 61000-4-11
Environmental class (during operation)	Class 3C3 according to IEC 60721-3-3 Class 3S2 according to IEC 60721-3-3
Maximum acceleration under shock impact (during operation)	150 m/s <sup>2</sup> at 11 ms
Maximum acceleration under vibrational stress (during operation)	10 m/s <sup>2</sup> at 13...200 Hz
Maximum deflection under vibratory load (during operation)	1.5 mm at 2...13 Hz
Volume of cooling air	16 m <sup>3</sup> /h
Overvoltage category	Class III

<b>Regulation loop</b>	Adjustable PID regulator
<b>Electromagnetic emission</b>	Radiated emissions environment 1 category C2 conforming to EN/IEC 61800-3 2...16 kHz shielded motor cable Conducted emissions with integrated EMC filter environment 1 category C1 conforming to EN/IEC 61800-3 2, 4, 8, 12 and 16 kHz shielded motor cable <5 m Conducted emissions with additional EMC filter environment 1 category C1 conforming to EN/IEC 61800-3 4...12 kHz shielded motor cable <20 m Conducted emissions with additional EMC filter environment 1 category C2 conforming to EN/IEC 61800-3 4...12 kHz shielded motor cable <50 m Conducted emissions with additional EMC filter environment 2 category C3 conforming to EN/IEC 61800-3 4...12 kHz shielded motor cable <50 m Conducted emissions with integrated EMC filter environment 1 category C2 conforming to EN/IEC 61800-3 4...16 kHz shielded motor cable <5 m Conducted emissions with integrated EMC filter environment 1 category C2 conforming to EN/IEC 61800-3 2, 4, 8, 12 and 16 kHz shielded motor cable <10 m
<b>Vibration resistance</b>	1 gn (f = 13...200 Hz) conforming to EN/IEC 60068-2-6 1.5 mm peak to peak (f = 3...13 Hz) - drive unmounted on symmetrical DIN rail - conforming to EN/IEC 60068-2-6
<b>Shock resistance</b>	15 gn conforming to EN/IEC 60068-2-27 for 11 ms
<b>Relative humidity</b>	5...95 % without condensation conforming to IEC 60068-2-3 5...95 % without dripping water conforming to IEC 60068-2-3
<b>Noise level</b>	45 dB
<b>Pollution degree</b>	2
<b>Ambient air transport temperature</b>	-25...70 °C
<b>Ambient air temperature for operation</b>	-10...50 °C without derating 50...60 °C with current derating 2.2 % per °C
<b>Ambient air temperature for storage</b>	-25...70 °C

## Packing Units

<b>Unit Type of Package 1</b>	PCE
<b>Number of Units in Package 1</b>	1
<b>Package 1 Height</b>	18.000 cm
<b>Package 1 Width</b>	18.500 cm
<b>Package 1 Length</b>	18.500 cm
<b>Package 1 Weight</b>	1.705 kg
<b>Unit Type of Package 2</b>	S06
<b>Number of Units in Package 2</b>	30
<b>Package 2 Height</b>	75.000 cm
<b>Package 2 Width</b>	60.000 cm
<b>Package 2 Length</b>	80.000 cm
<b>Package 2 Weight</b>	64.840 kg

## Contractual warranty

<b>Warranty</b>	18 months
-----------------	-----------

## Bền vững

Nhãn **Green Premium™** là cam kết của Schneider Electric trong việc cung cấp sản phẩm với hiệu suất môi trường tốt nhất. Green Premium cam kết tuân thủ các quy định mới nhất, minh bạch về tác động môi trường, cũng như các sản phẩm tuần hoàn và CO<sub>2</sub> thấp.

**Hướng dẫn đánh giá tính bền vững của sản phẩm** là tài liệu kỹ thuật phổ thông giúp làm rõ các tiêu chuẩn nhãn sinh thái toàn cầu và cách diễn giải việc khai báo môi trường.

[Tìm hiểu thêm về Green Premium >](#)

[Hướng dẫn đánh giá về sự bền vững của sản phẩm >](#)

## Hiệu suất sức khỏe

 Mercury Free

 Rohs Exemption Information [Yes](#)

**Reach Regulation** [REACH Declaration](#)

**Eu Rohs Directive** Pro-active compliance (Product out of EU RoHS legal scope)

**China Rohs Regulation** [China RoHS declaration](#)

**Weee** The product must be disposed on European Union markets following specific waste collection and never end up in rubbish bins

## Dimensions Drawings

### Dimensions

#### Drive without EMC Conformity Kit

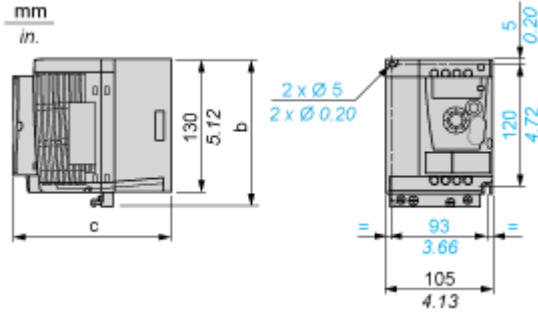

Dimensions in mm

b	c
142	156.2

Dimensions in in.

b	c
5.59	6.15

#### Drive with EMC Conformity Kit

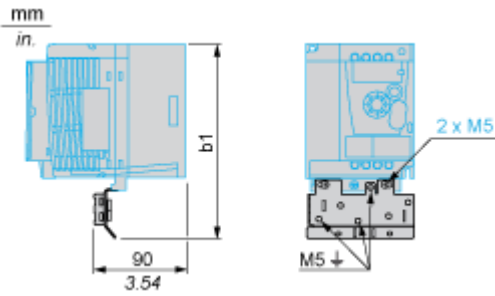

Dimensions in mm

b1
188.2

Dimensions in in.

b1
7.41

## Mounting and Clearance

### Mounting Recommendations

---

#### Clearance for Vertical Mounting

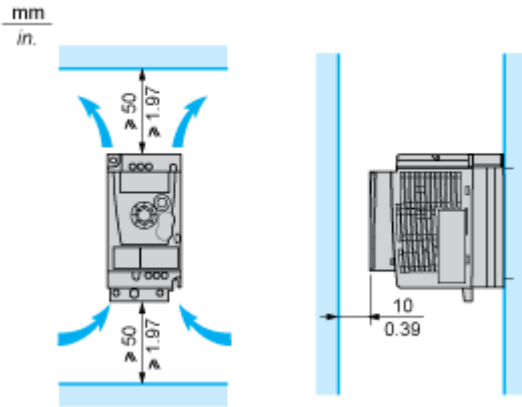

#### Mounting Type A

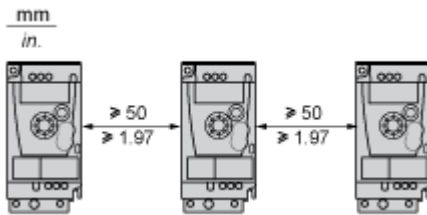

#### Mounting Type B

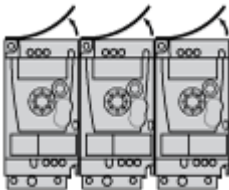

Remove the protective cover from the top of the drive.

#### Mounting Type C

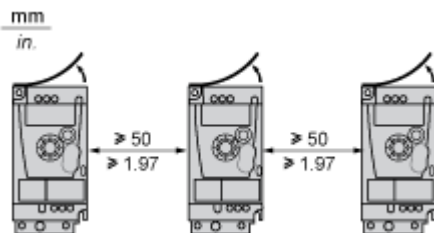

Remove the protective cover from the top of the drive.





## Recommended Schemes

---

### 2-Wire Control for Logic I/O with Internal Power Supply

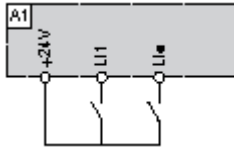

LI1 : Forward

LI• : Reverse

A1 : Drive

### 3-Wire Control for Logic I/O with Internal Power Supply

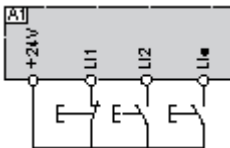

LI1 : Stop

LI2 : Forward

LI• : Reverse

A1 : Drive

### Analog Input Configured for Voltage with Internal Power Supply

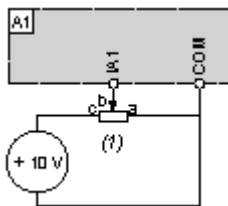

(1) 2.2 k $\Omega$ ...10 k $\Omega$  reference potentiometer

A1 : Drive

### Analog Input Configured for Current with Internal Power Supply

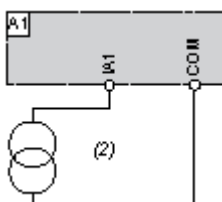

(2) 0-20 mA 4-20 mA supply

A1 : Drive

## Connected as Positive Logic (Source) with External 24 vdc Supply

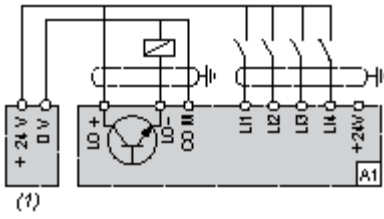

(1) 24 vdc supply

A1 : Drive

## Connected as Negative Logic (Sink) with External 24 vdc supply

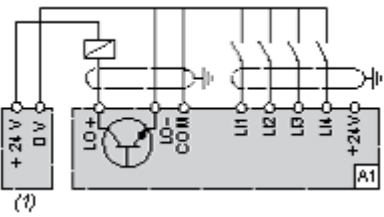

(1) 24 vdc supply

A1 : Drive

## Performance Curves

### Torque Curves

---

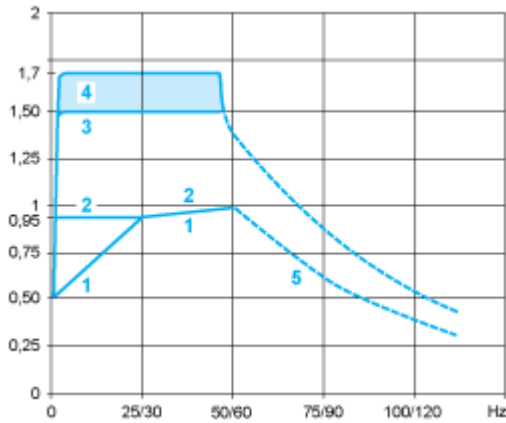

- 1 : Self-cooled motor: continuous useful torque **(1)**
- 2 : Force-cooled motor: continuous useful torque
- 3 : Transient overtorque for 60 s
- 4 : Transient overtorque for 2 s
- 5 : Torque in overspeed at constant power **(2)**

(1) For power ratings  $\leq 250$  W, derating is 20% instead of 50% at very low frequencies.

(2) The nominal motor frequency and the maximum output frequency can be adjusted from 0.5 to 400 Hz. The mechanical overspeed capability of the selected motor must be checked with the manufacturer.